



**DISPLAY**  
CONCEPTS

# Magnum

## Refrigerated Pastry Showcase

H137 – H120



**Features:** Professional ventilated pastry showcase with tubular epoxy-painted steel base and options for wheels or adjustable feet. Enbloc body is lined throughout in stainless steel, insulated with injected polyurethane. The bottom display surface is inclined with removable stainless steel panels. Heated front glass panel opens downward and is supported by polished stainless steel uprights with internal ducting for electrical wiring. Both front and side glass panels are tempered and heated. Two ambient display shelves on H137, one ambient shelf on H120. Rear is enclosed with a roller blind. LED lighting underneath top surface and shelves. Ventilated refrigeration system with potentiometer for fan speed adjustment, automatic defrosting with on-off function and control panel with electronic thermostat. Automatic showcase condensate evaporation with integral motor, condensate drain for connection to drainage system with remote motor. The condenser unit can be integral in the showcase or remote, at a distance of up to 20 meters. Can be channeled in-line with MAGNUM ice cream & gelato, and confectionery showcases.

- Structure:** stainless steel & anodized aluminum
- Front glass:** downward opening
- Glass panels:** tempered and heated
- Front & side base panels:** lacquered in a variety of RAL colors
- Ventilation:** ventilated forced air
- Compressor:** available integral or remote
- Defrosting:** automatic reverse cycle
- Lighting:** high luminosity LED
- Electric:** 220V 15A 1Phase
- Plumbing:** none required, condensate evaporator included

### MAGNUM PASTRY SHOWCASE

**Operating temperature** 32°F/+41°F (0°C/+5°C)

**Climate Class 4** (30° C- 55% R.H.)

**Relative Humidity** 55% -60%



info@fmdisplayconcepts.com  
800-889-3975  
www.fmdisplayconcepts.com



**DISPLAY**  
CONCEPTS

# Magnum

## Refrigerated Pastry Showcase

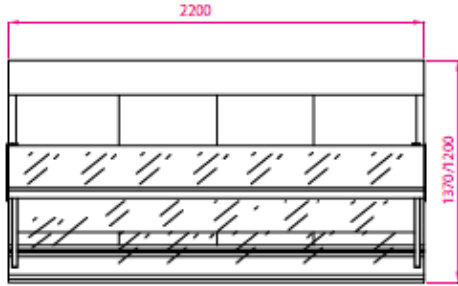

2150

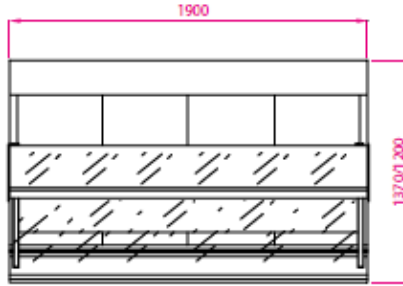

1850

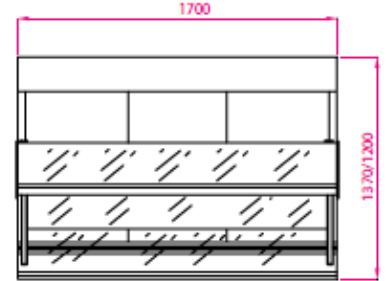

1650

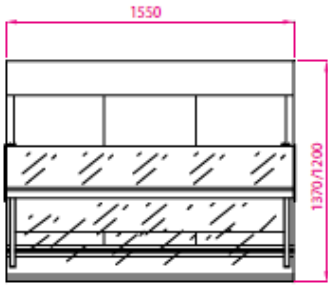

1500

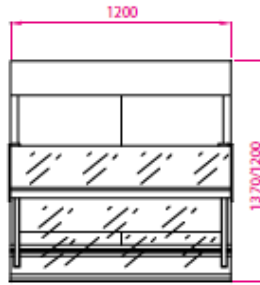

1150

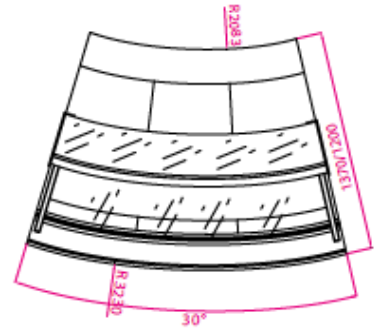

ANGOLO ESTERNO 30°

### H137

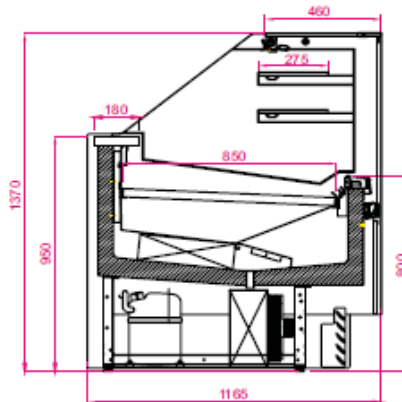

### H120

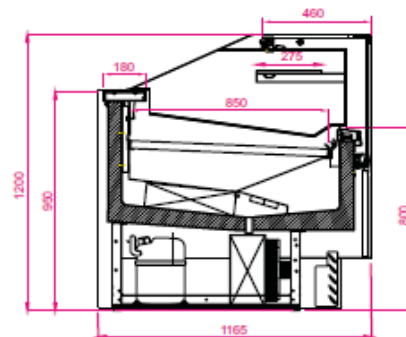

Feature	inches	mm
Depth (All)	45.9	1165
Height (120)	47.2	1200
Height (137)	53.9	1370
Length (L-1150)	47.2	1200
Length (L-1500)	61.0	1550
Length (L-1650)	66.9	1700
Length (L-1850)	74.8	1900
Length (L-2150)	86.6	2200

**frigomeccanica**  
Arredamenti Bar

ETL LISTED  
   
 Intertek Intertek  
 3094110  
 CONFORMS TO UL STD 471; NSF STD 7  
 CERTIFIED TO CAN/CSA C22.2 STD No. 120

CE