

KART

YOUR BAR IS EVERYWHERE



Frigomeccanica 



FRIGOMECCANICA INDUSTRIES

THE FRIGOMECCANICA GROUP, AN ALL-ITALIAN ORGANISATION, OPERATES ON THE MARKET UNDER THE FRIGOMECCANICA, STILTEK, OFFICINE 900 AND FRIMAR BRANDS. THE GROUP IS A SECTOR LEADER AND IS SYNONYMOUS WITH QUALITY, COMPETITIVENESS AND PROFESSIONALISM ON THE DOMESTIC AND INTERNATIONAL MARKET. IT SUPPLIES BAR FURNITURE, SHOWCASES FOR ICE-CREAM, PASTRY PRODUCTS, FOOD, DELICATESSEN FOODS AND FURNITURE FOR BAKERIES AND PUBLIC ESTABLISHMENTS IN GENERAL. SINCE IT OPENED NEARLY 40 YEARS AGO, THE STRENGTH OF FRIGOMECCANICA HAS ALWAYS BEEN TECHNOLOGICAL RESEARCH AND VISUAL DESIGN. THE RESULTS ACHIEVED IN BOTH AREAS, COORDINATED WITH EXPERIENCE, PROFESSIONALISM AND ENTHUSIASM, ALLOW THE GROUP TO SUPPLY THE BEST OF WHAT THE MARKET HAS TO OFFER.



DESIGN AND TECHNOLOGY
MADE IN ITALY



WATCH OUR VIDEO



KART is a mobile bar on wheels, practical and convenient for exploiting outdoor spaces to the full or for use during temporary events.

Easy to move around and sanitise, Kart is a genuine bar counter placed on wheels, useful for transferring your business into outdoor or temporary areas.

Purchasing Kart is a good investment, because after mobile use it can be installed in the normal way by just removing the wheels and canopy.

KART
YOUR BAR IS EVERYWHERE

KART
coffee bar

KART
*pozgetti
ice cream*

KART
cocktail

KART
ice cream

Frigomeccanica





GBR
ITA
0135

MEC-14258

COFFEE - ICE CREAM

MADE IN ITALY

KART
coffee bar



KART
*pozzetti
ice cream*

THE KART COFFEE BAR RANGE
ENABLES REFRIGERATED
OUTFITS WITH DIFFERENT
LENGTHS AND LAYOUTS.



The wheels are swivel type
and complete with parking brake.



All Coffee modules have sink and tap, supplied by
an electric pump. The pump is connected to the clean
water tank, while the drain discharges into the dirty
water tank. They are both removable and 20 litres in
capacity. The coffee machine can also be connected
to the clean water tank.

CAFFE' DEI POETI

CAFFE' DEI POETI

ITA

GBR
USA
0031

MADE IN ITALY

KART
coffee bar



KART / 10

KART
coffee bar

KART COMPARTMENTS ARE BOTH REFRIGERATED AND AMBIENT AND MAY FEATURE A HOPPER DRAWER FOR COFFEE GROUNDS, STAINLESS STEEL DOORS OR REFRIGERATED DRAWER UNITS.



KART / 11

KART

cocktail

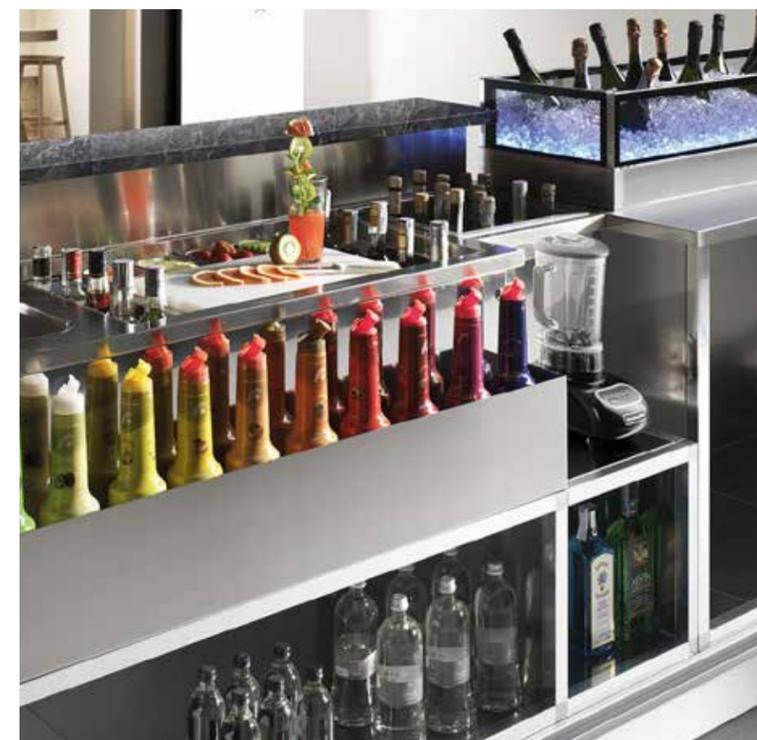

KART COCKTAIL IS ABOUT 150 CM LONG AND IS EQUIPPED WITH INSULATED ICE BOX, INGREDIENT TRAYS, BOTTLE RAILS AT THE SIDE AND REAR, REMOVABLE CHOPPING-BOARD AND MIXER STAND. THE SINK WITH TAP IS SUPPLIED BY AN ELECTRIC PUMP CONNECTED TO THE REMOVABLE CLEAN WATER TANK.

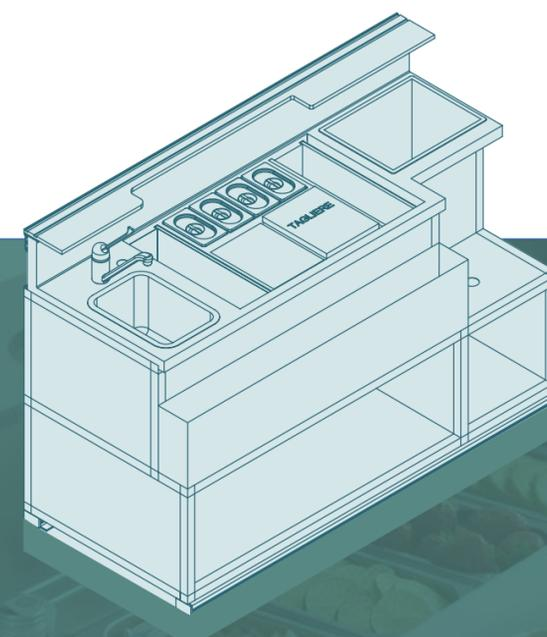



KART ALSO COMES IN ICE-CREAM VERSION, WITH A WIDE VARIETY OF ICE-CREAM SHOWCASES WITH DIFFERENT SIZES AND PERFORMANCES, AGAIN ON WHEELS AND WITH CANOPY WITH LED LIGHTING.

KART

*pozze
tti
ice cream*



KART

pozzetti
ice cream

TREVI

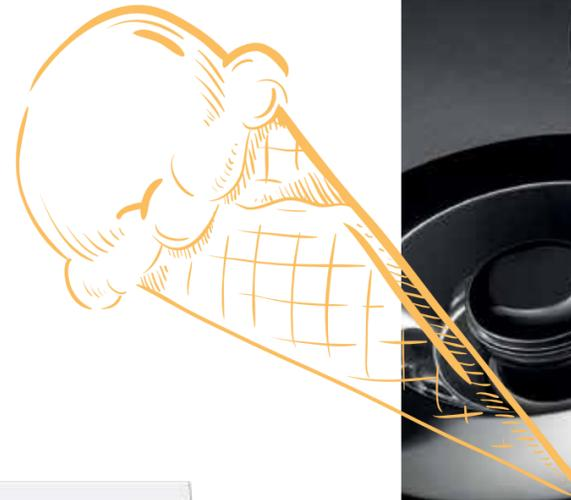
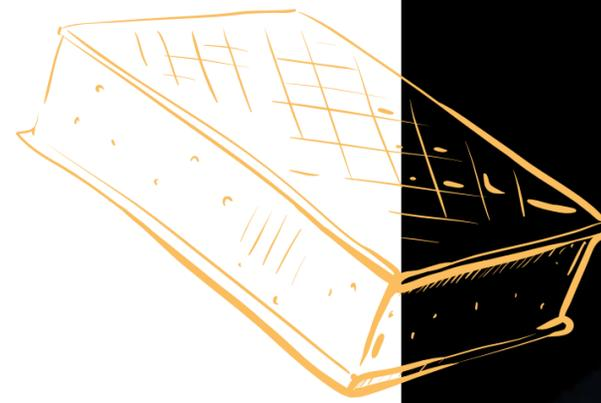
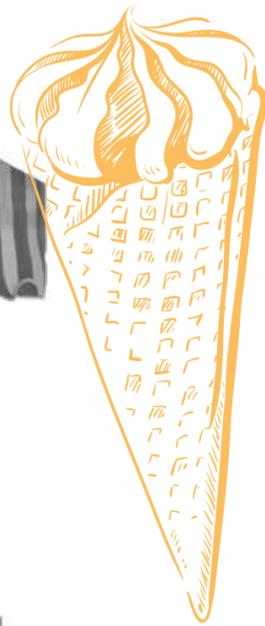

KART

pozzetti
ice cream

CONTAINER



KART IS BUILT THROUGHOUT IN ITALY IN OUR PLANTS, SO AS WELL AS THE FINISHES AND OUTFITS FEATURED IN THIS CATALOGUE, IT CAN BE CREATED WITH A LARGE NUMBER OF "BESPOKE" FINISHES AND SERVICES, TAILOR-MADE FOR YOUR BUSINESS AND NEEDS.

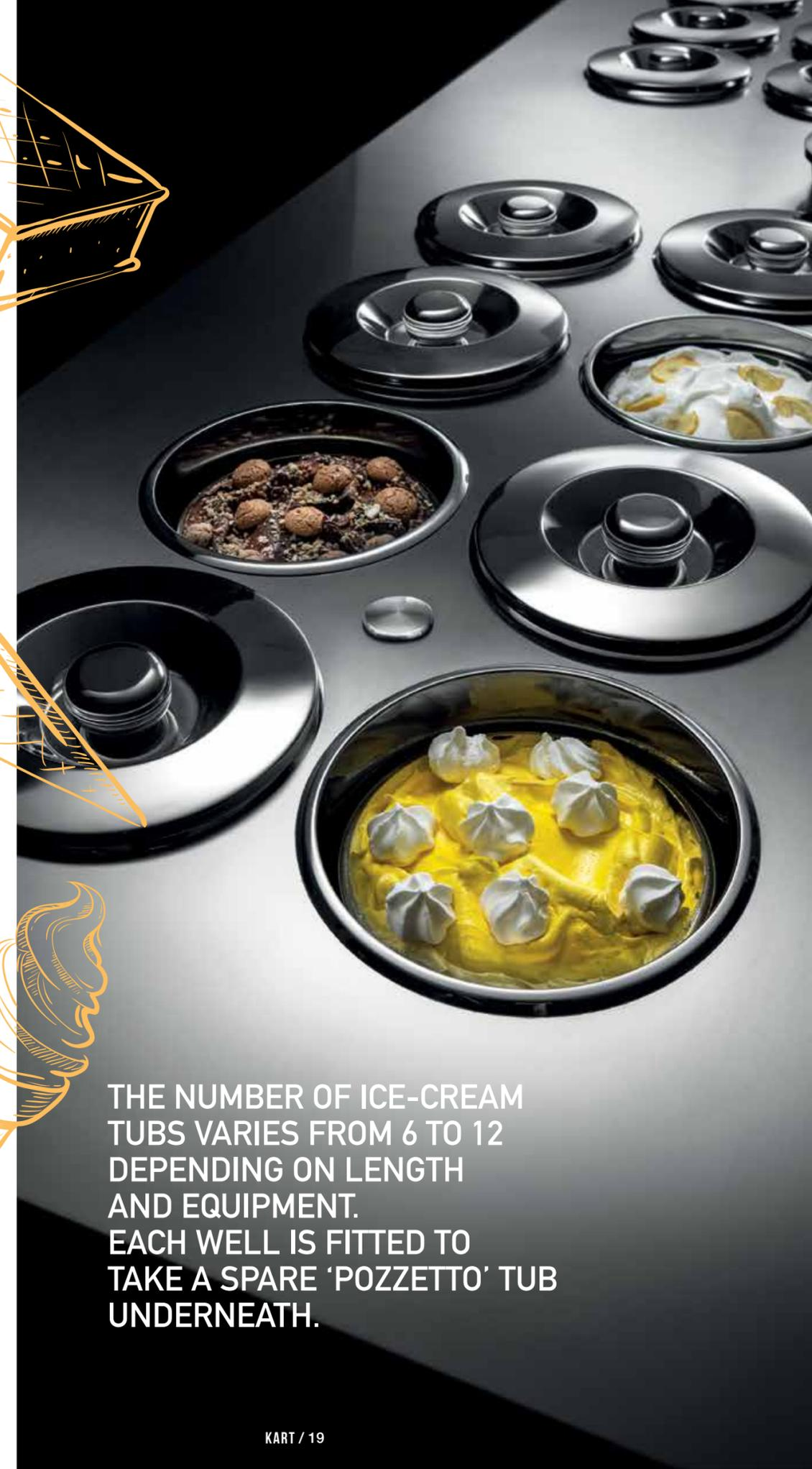

THE NUMBER OF ICE-CREAM TUBS VARIES FROM 6 TO 12 DEPENDING ON LENGTH AND EQUIPMENT. EACH WELL IS FITTED TO TAKE A SPARE 'POZZETTO' TUB UNDERNEATH.



KART
pozzetti
ice cream

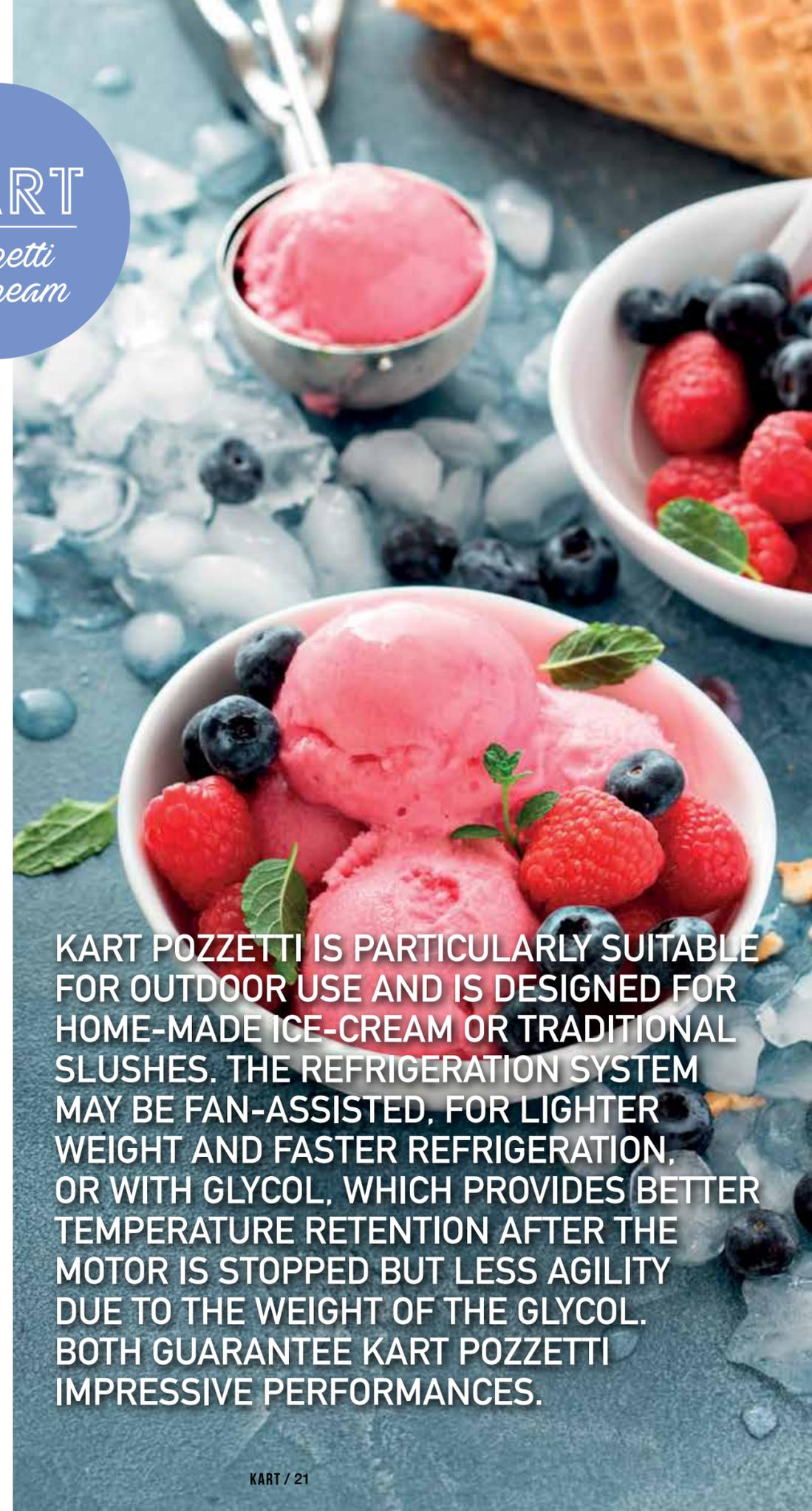

KART POZZETTI IS PARTICULARLY SUITABLE FOR OUTDOOR USE AND IS DESIGNED FOR HOME-MADE ICE-CREAM OR TRADITIONAL SLUSHES. THE REFRIGERATION SYSTEM MAY BE FAN-ASSISTED, FOR LIGHTER WEIGHT AND FASTER REFRIGERATION, OR WITH GLYCOL, WHICH PROVIDES BETTER TEMPERATURE RETENTION AFTER THE MOTOR IS STOPPED BUT LESS AGILITY DUE TO THE WEIGHT OF THE GLYCOL. BOTH GUARANTEE KART POZZETTI IMPRESSIVE PERFORMANCES.

KART
*pozzezzi
ice cream*

life.

ITA

GBR
USA
0031

MEC-329

MADE IN ITALY

KART

ice cream

GHOST





CAFFE DEL DUOMO

ITA

GBR
USA
0216

MADE IN ITALY

KART
ice cream



KART
coffee bar



KART
ice cream



KART
coffee bar

THE KART CANOPY MAY BE WITH OR WITHOUT VALANCE (DEPENDING ON THE MODEL AND REQUIREMENTS); BOTH SOLUTIONS HAVE TWO LED LIGHTING UNITS. THE SINK AND TAP, WHEN INSTALLED, ARE CONNECTED TO CLEAN AND DIRTY WATER TANKS OF 20 LITRE (10 LITRES FOR COCKTAIL VERSION).

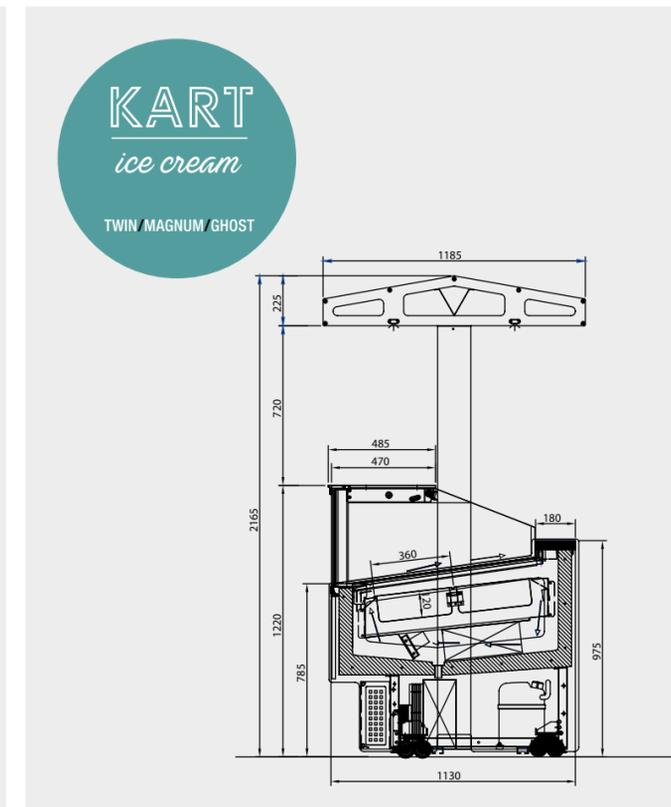
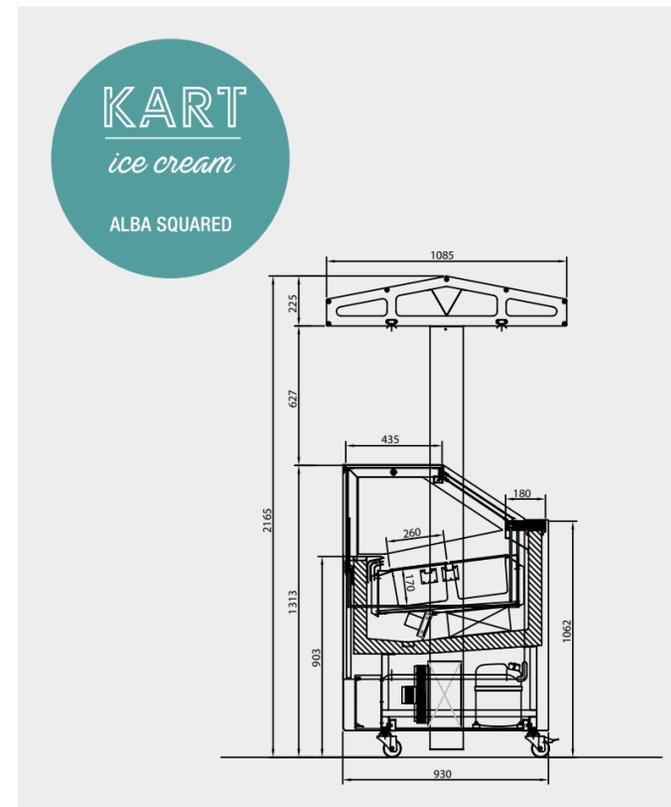
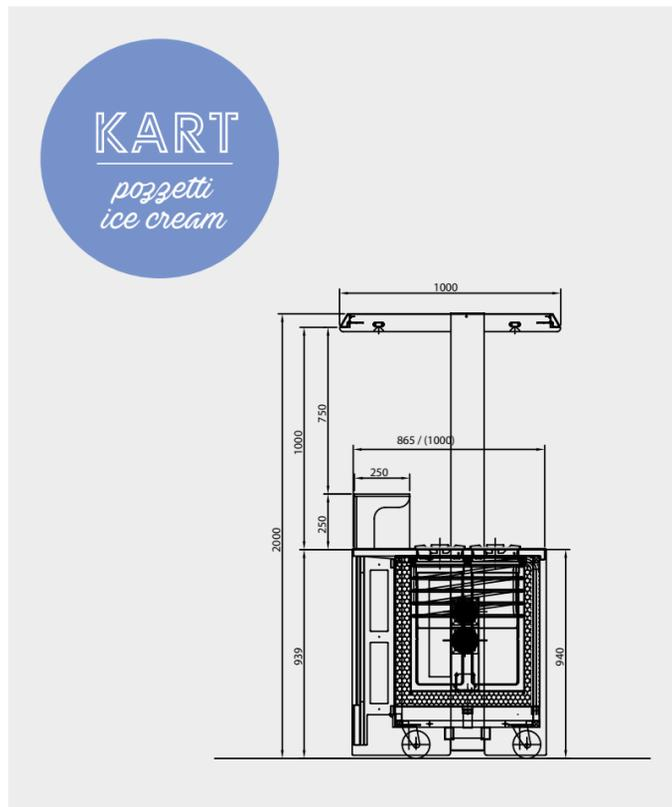
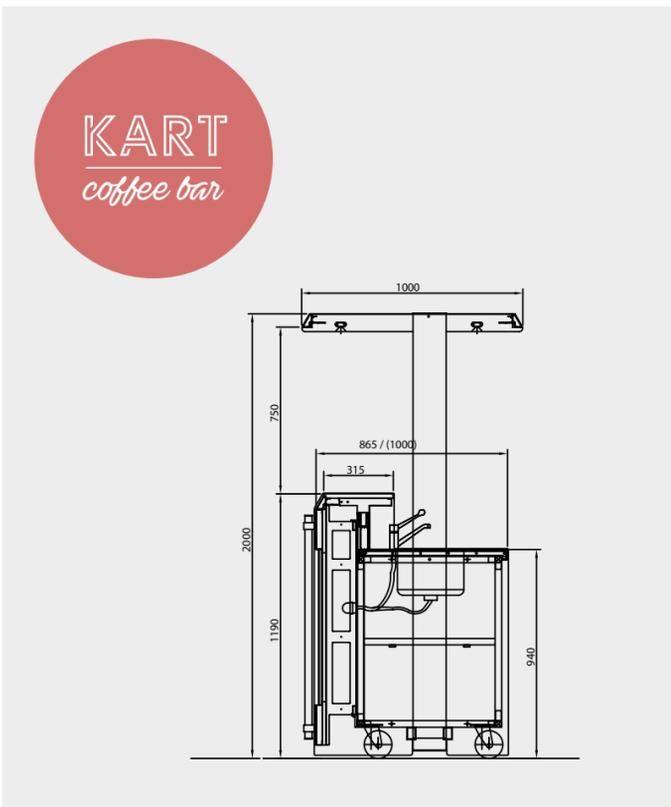

LAMINATED COUNTERTOP (STANDARD)

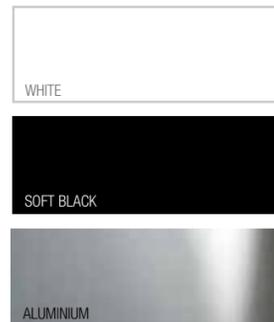

ALU/COMPACT LAMINATED COUNTERTOP (STANDARD)



AGGLOMERATE/MARBLE/CORIAN COUNTER-TOP (OPTIONAL)

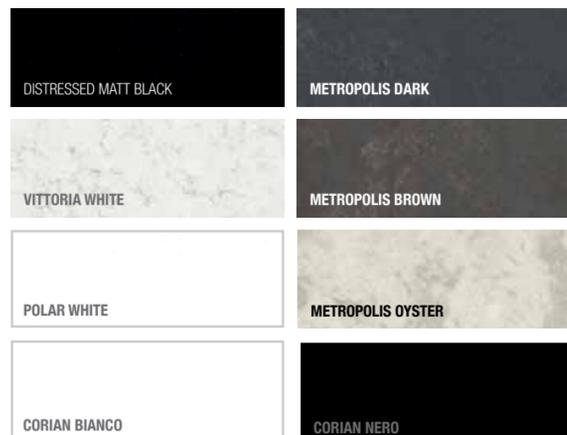

STEEL FRONT PANELS, STANDARD COLOURS



**STEEL FRONT PANELS IN SPECIAL COLOURS
* FOR INDOOR USE ONLY**

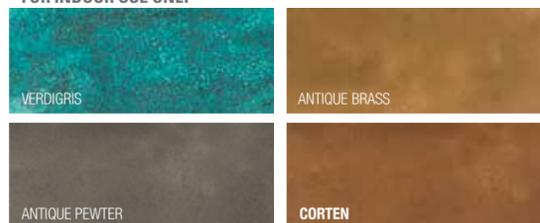

The electricity supply voltage for lighting and refrigeration functions is 220V or 380V depending on the equipment requested, and may be supplied by the mains or a power generator. The rugged base structure is in powder-painted steel and is "palletised" to enable vehicle transfer with the aid of a pallet truck or forklift. After use, Kart should be stored indoors or beneath a waterproof cover.





Product Concept
Team Frigomeccanica
Enzo Di Serafino
Luca Lallone
Alessio Scaramazza
Francesco Di Egidio

Art Direction
Enzo Di Serafino
Federica Bastianoni

In collaboration with
Roberto Garbugli
per l'estetica Container

Frigomeccanica reserves the right to make changes to the products shown in this catalogue at any time without notice.

Frigomeccanica declines any liability which may derive from the misuse of the product illustrated, especially from failure to comply with laws, regulations and municipal orders regarding public health and the use of public spaces.
The illustrations are intended only to represent the product and not its use, which may be governed by different laws and regulations depending on the place of use.
Frigomeccanica advises you to consult your local public safety and health authorities before using the products illustrated outdoors or in public places.



M A D E I N I T A L Y

FRIGOMECCANICA

Via del Progresso, 10
64023 Mosciano S. Angelo (TE) Italy

Tel. +39 085 80793
Fax +39 085 8071464

www.frigomeccanica.com
info@frigomeccanica.com

Numero Verde
800-312302